



---

# 1 Brief introduction

BLDC-2208A is designed for high voltage BLDC Motors less 300w. It uses DSP technology to reach high torque, low noise and low vibration. More rich functions such as over-voltage protection, locked-rotor protection, and alarm signal output are combined.

## 1.1 Features

- Acc/Dec time setting
- Pole-pairs selection
- Open/closed loop control
- Max output current P-sv setting
- Alarm indication
- Built-in RV speed setting
- External potentiometer speed setting
- External analog signal speed setting
- Pulse frequency and PWM speed setting

## 2 Electrical properties and environmental indicators

### 2.1 Electrical properties

Driver parameter	Min Value	Typical Value	Max Value
Voltage input DC (V)	180	220	265
Current output(A)	-	-	4
Motor speed range(rpm)	-	-	20000
Hall signal voltage(V)	-	-	5
Hall drive current (mA)	12	-	-
External potentiometer(K $\Omega$ )	-	10	-

### 2.2 Environmental indicators

Heat Sinking Method	Natural cooling or fan-forced cooling
Atmosphere	Avoid dust, oily mist and corrosive air
Operating Temperature	0 ~ +40°C
Ambient Humidity	90% or less (non-condensing)
Vibration Resistance	5.7m/s <sup>2</sup> maximum
Storage Temperature	0 ~ +50°C

### 3 Dimension(Unit: mm)

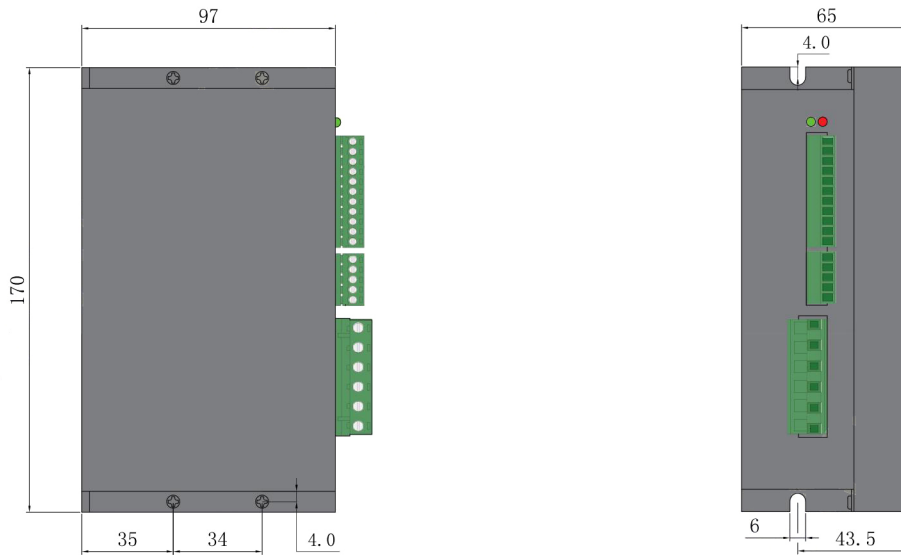

### 4 Driver interface and wiring diagram

#### 4.1 Driver interface

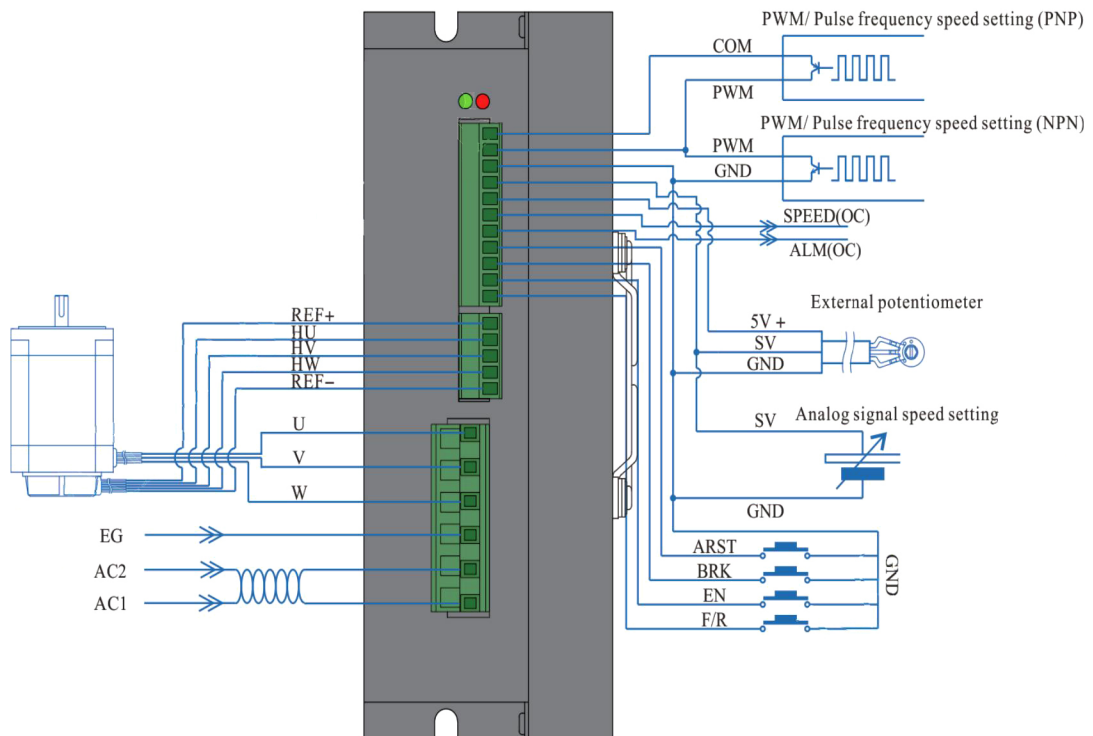



## 4.2 Port signal description

Signal category	Terminal	Functional Description
Control signal	COM	External power common port (Eg, PLC24V output port)
	PWM	Pulse frequency/duty ratio signal input, selected by SW1 SW2
	GND	Controlling signal GND
	SV	External speed setting input
	5V+	Inner 5V terminal, external potentiometer can be connected.
Output signal	SPEED	<p>Pulse frequency output (open-drain output) corresponded with running speed. Speed can be figured out.</p> <p>According:</p> $N(\text{rpm}) = (F/P) \times 60/3$ <p>F: Output pulse frequency (HZ); P: Motor pole pairs; N: Motor speed</p> <p>For example: Motor has 4 pole pairs,</p> $F = 1\text{sec}/2\text{ms} = 500\text{Hz}$ $N(\text{rpm}) = (500/4) \times 60/3 = 2500$ 
	ALM	Motor or driver fault signal output. It is 5v in normal situation and 0V when fault occurs.
Control signal	ARST	To reset fault, connect ARST with GND.
	BRK	Motor brake stop control signal; BRK and GND connect, motor runs; motor brake stops when BRK and GND disconnect.
	EN	Stop signal terminal; EN connects GND, motor runs, otherwise motor stops.
	F/R	Motor direction control terminal; F/R and COM disconnect, motor will rotate clockwise, and otherwise, motor will rotate anticlockwise.
Hall signal	REF+	Hall sensor signal power supply+
	HU、HV、HW	Hall sensor signal Hu、Hv、Hw
	REF-	Hall sensor signal-
Motor connection	U、V、W	Motor line U、V、W phase.
Power connection	EG	EG Ground
	AC2、AC1	AC Input(VAC180-265)

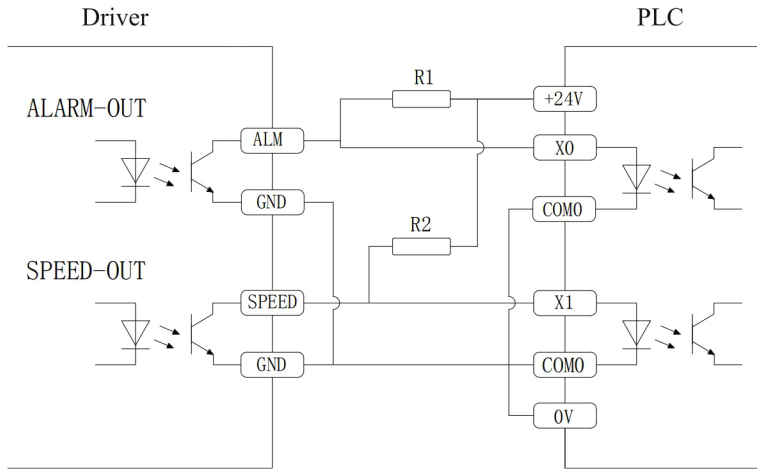

### 4.3 Output signal connection diagram



 R1,R2=1KΩ 12V  
 Notice R1, R2=2KΩ 24V

## 5 Function setting

### 5.1 ACC/DEC time setting

Set acceleration time and deceleration time by ACC, range is 0.3-15s. Acceleration time is time needed from 0 to rated speed.

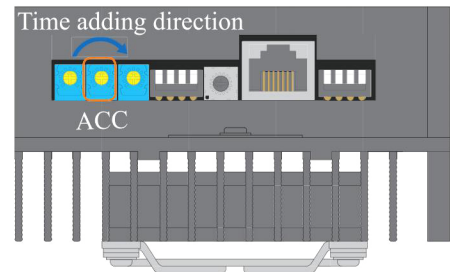

### 5.2 Speed setting modes selection

SW1	SW2	Speed setting modes
OFF	OFF	Built-in potentiometer RV
ON	OFF	External analog voltage/External potentiometer
OFF	ON	PWM
ON	ON	Pulse frequency

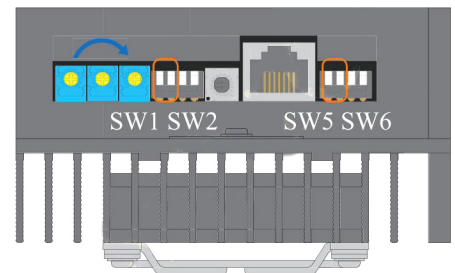

### 5.3 Motor poles pair selection

SW5	SW6	Pairs of poles
ON	OFF	2
OFF	ON	4
ON	ON	5
OFF	OFF	Cluster can change according to RS485.

 Right poles should be selected via Notice SW5 SW6 when closed loop mode is running

## 5.4 Motor matching

Select back electromotive force to match Hall signal rising edge or falling edge.

OFF	Back electromotive force corresponds Hall signal rising edge
ON	Back electromotive force corresponds Hall signal falling edge

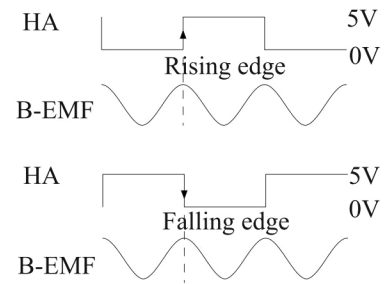

## 5.5 Open/Closed loop setting

Switch	OFF	ON
SW7	Closed loop	Open loop
SW8	Speed closed loop	Speed and current closed loop

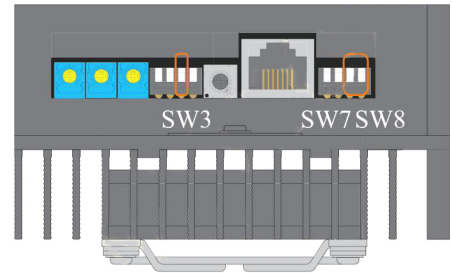

## 5.6 Peak current setting

Use P-sv to set the output peak current. When load is increased suddenly, the output current will be limited by the setting value, which reduces motor speed and protects the motor. Current setting ranges: 1.2-13A

As the admissible error of real current and setting value is  $\pm 10\%$ , to ensure safety, set current lower accordingly.

 The duration of peak current is 3s when load increases suddenly. After 3s, if load is not reduced, over current protection will be set up and driver stops working.

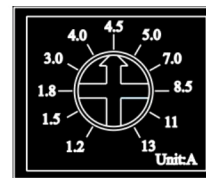

## 5.7 RS-485 communication

Set parameter via upper computer. Please select communication address via ADDR.

## 5.8 RS-485 terminal resistance

When RS485 has a long bus, a terminal resistance is suggested to connect to reduce signal interference.

ON	RS-485 terminal 120Ω resistance connection
OFF	RS-485 terminal 120Ω resistance disconnection

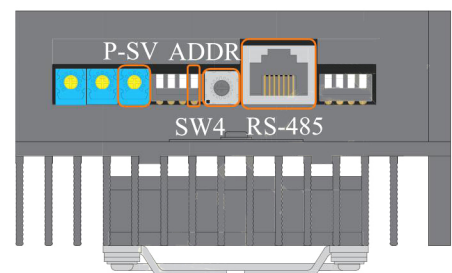

## 5.9 Motor start and stop

### ◇ Motor start and stop

EN and GND terminal is short circuit in default. If EN disconnects with GND, motor stops.

Connecting or disconnecting (use PLC or a switch) GND and EN can control the start or stop of the motor.

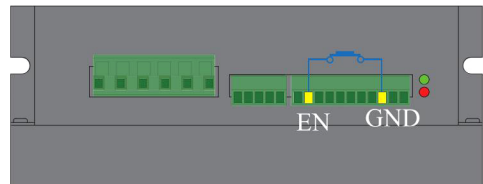

### ◇ Brake

BRK and GND terminal disconnect in default. Motor will brake stop if BRK and GND are in short circuit.

Connecting or disconnecting (use PLC or a switch) GND and EN can control the start or brake of the motor.

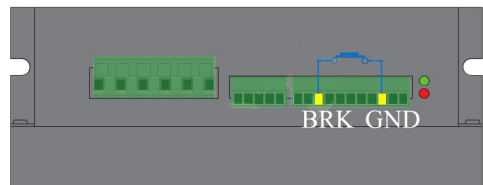

Difference between EN and BRK

- Notice  1. EN is for natural stop, BRK is for sudden stop.  
2. EN and BRK have the same startup state  
3. When selecting one of the start modes, another mode must be kept as default setting.

## 5.10 Direction control

F/R and GND disconnect in default, motor runs clockwise.

Connect F/R and COM, the motor will rotate anticlockwise.

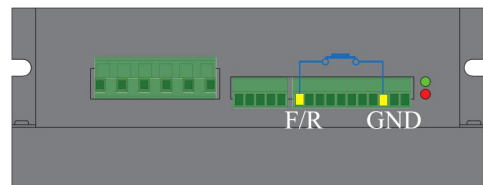

- Notice  The direction is judged from the quarter view of the axle.

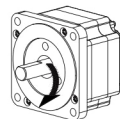

## 6 Speed setting methods and settings

### 6.1 Speed setting via built-in potentiometer

Motor speed increases when RV knobs is rotated clockwise; otherwise, speed decreases.

SW1	OFF
SW2	OFF
SW7	OFF:Open loop ON:Closed loop
SW8	OFF:Speed close loop ON:Speed and current speed

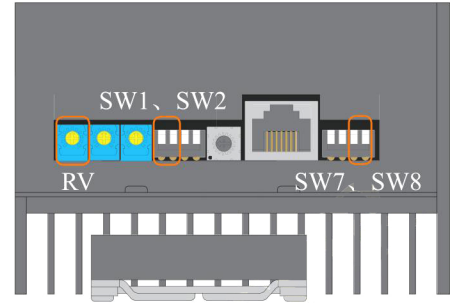

Built-in speed potentiometer and motor speed diagram (open-loop no-load)

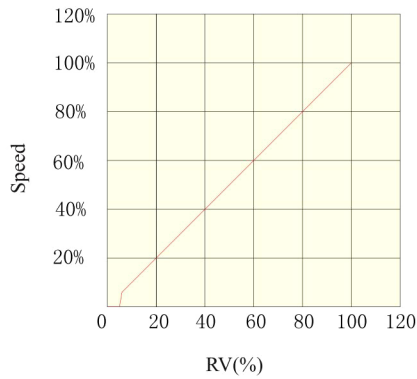

Built-in speed potentiometer and motor speed diagram (closed-loop no-load)

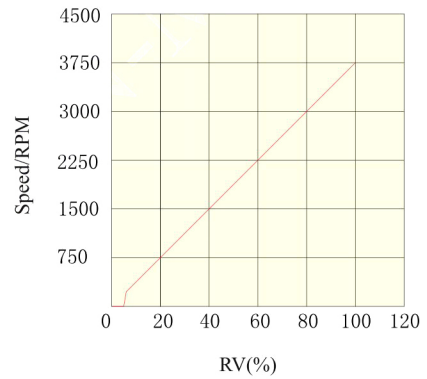

### 6.2 External potentiometer

Use a suitable potentiometer with a resistance value of 10KΩ; when connect external potentiometer, the middle terminal connects to SV; the other two terminals connect to 5V+ and GND.

SW1	ON
SW2	OFF
SW7	OFF:Open loop ON:Closed loop
SW8	OFF:Speed close loop ON:Speed and current speed.
RV	RV should be rotated anticlockwise to limit position

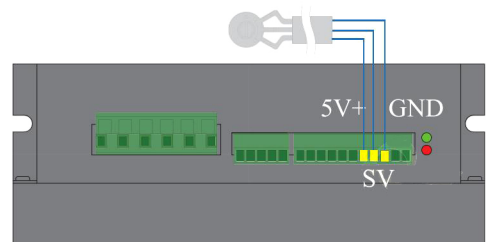

### 6.3 Speed setting via external analog signal 0-5V

SW1	ON
SW2	OFF
SW7	OFF:Open loop ON:Closed loop
SW8	OFF:Speed close loop ON:Speed and current speed.
RV	RV should be rotated anticlockwise to limit position

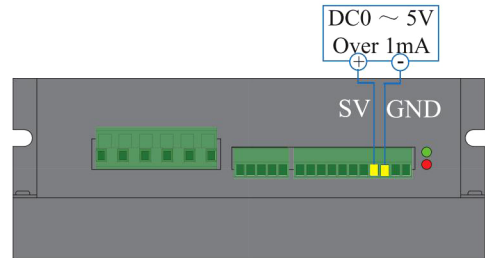

Relational graph between the analog signal voltage and motor speed (open-loop no-load)

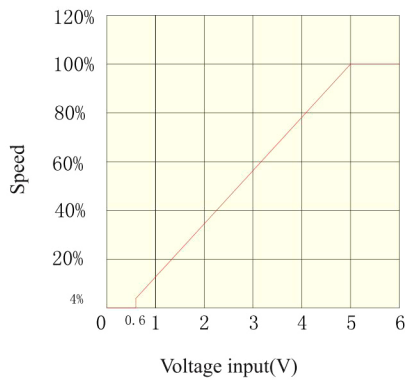

The analog signal voltage can be 0-5VDC; when the voltage is 0.6VDC, the motor speed reaches 4% of fastest speed; when the voltage is 5 VDC, the motor speed reaches maximum value, which depends on the motor specification and power voltage.

Relational graph between the analog signal voltage and motor speed (closed-loop no-load)

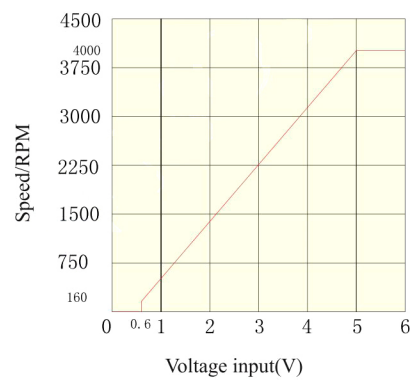

When analog voltage is 0.6V, motor speed is about 160rpm; when analog voltage is 5V, motor reaches max speed 4000rpm.

- 1.Motor parameter and power supply also affect motor speed.
- 2.Set poles setting right via SW5 SW6 or RS-485.

## 6.4 Speed setting via pulse frequency

SW1	ON
SW2	ON
SW7	OFF:Closed loop ON:Open loop
SW8	OFF:Speed closed loop ON:Speed and current closed loops
RV	RV should be rotated anticlockwise to limit position

Relational graph between the impulse frequency and motor speed (open-loop no-load)

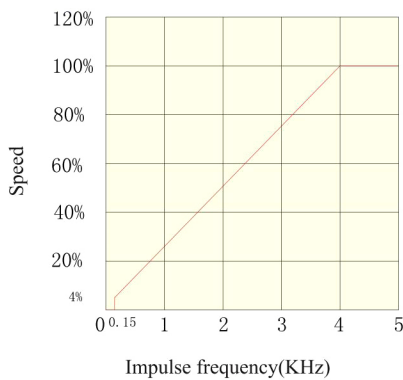

When the impulse frequency is 0.15KHz, the motor speed reaches 4% of fastest speed; when the impulse frequency is 4KHz, the motor speed reaches maximum value, which depends on the motor specification and power voltage.

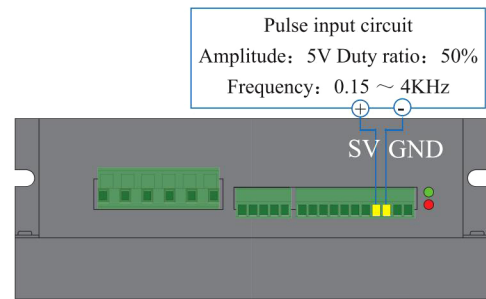

Relational graph between the impulse frequency and motor speed (closed-loop no-load)

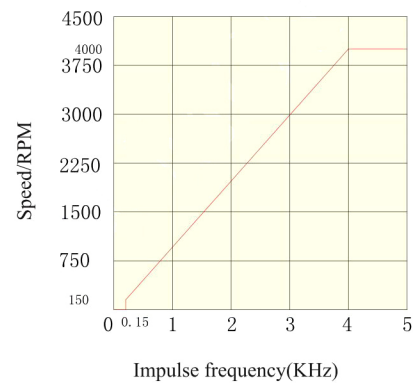

When the impulse frequency is 0.15KHz, the motor speed would be around 150rpm; when the impulse frequency is 4KHz, the motor speed reaches 4000rpm.

- 1.Motor speed would decrease via motor parameter and power supply
- 2.Set motor poles via SW5 SW6 or RS485.

## 6.5 PWM speed adjusting

SW1	OFF
SW2	ON
SW7	OFF:Closed loop ON:Open loop
SW8	OFF:Speed closed loopON:Speed and current closed loops
RV	RV should be rotated anticlockwise to limit position
Amplitude: 5V Frequency: 1 ~ 3KHz	

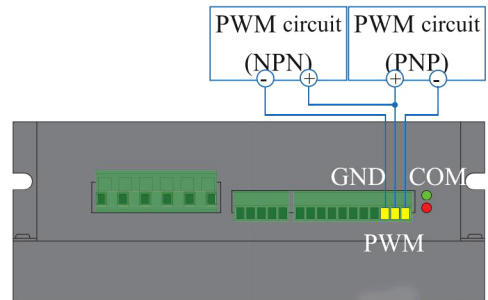

Relational graph between duty ratio and the motor speed (open loop no load)

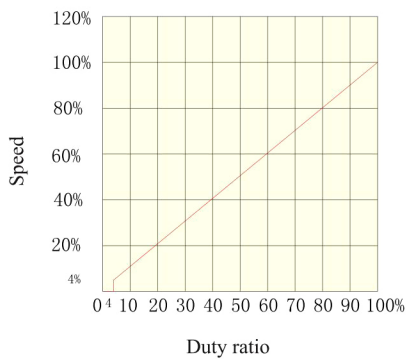

When duty ratio of pulse is 4%, motor speed is 4% of max speed;  
when duty ratio is 100%, motor reaches max speed. The max speed also depends on the motor specification and power voltage.

Relational graph between duty ratio and the motor speed (closed loop no load)

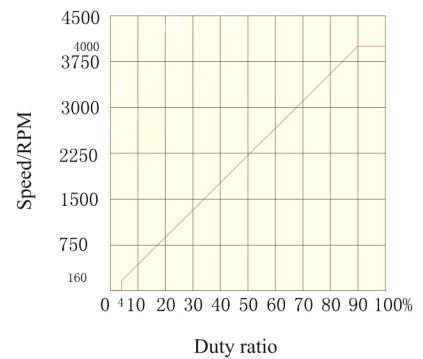

When duty ratio of pulse is 4%, motor speed would be around 160rpm, when duty ratio is 100%, motor reaches max speed 4000rpm.

- 1.Motor speed would decrease via motor parameter and power supply
- 2.Set motor poles via SW5 SW6 or RS485.



## 7 Status indicator. Issue handling

### 7.1 Status indicator

When over-current, Hall fault, over-temperature, and over voltage occurs, driver will give an alarm signal, and ALM terminal and GND will be in short circuit, ALM terminal will be changed to low level.

Motor driver stop working, alarm LED flashes.

Motor driver works, green light flickers; Motor driver in idle state, green light is on.

Led error display	Status statements	Cause	Solution
Red Led flickers once, Green Led flickers once	Over current	Short circuit with GND	Check if driver and motor wires are damaged
Red Led flickers twice, Green Led flickers once	Over temperature	Driver inner temperature is over Alarm detecting temperature	Reduce the ambient temperature.
Red Led flickers three times, Green Led flickers once	Over voltage	Power supply reaches 130% of rated voltage	Make sure power supply is rated value. Lighten load and extend acceleration time or deceleration time
Red Led flickers four times, Green Led flickers once	Low voltage	Power supply is less than rated voltage 60%	Make sure power supply is rated value and wires are not damaged
Red Led flickers five times, Green Led flickers once	Sensor fault	Wire or sensor connector is broken or uninstalled	Make sure driver and motor are connected well
Red Led flickers six times, Green Led flickers once	Over speed	Output speed of motor axle is over 4800r/min	Slow down motor speed
Red Led flickers eight times, Green Led flickers once	Locked-rotor	Over load and motor is stopped	Check the load
Red Led flickers nine times, Green Led flickers once	System error	Control system faults	Contact our technical supporter
Red Led flickers ten times, Green Led flickers once	Short circuit protection	Motor or wire is in short circuit	Check if motor and wires are short circuit
Red Led flickers eleven times, Green Led flickers twice	Power tube over current alarm	Motor or wire is in short circuit or load is over	Make sure model selection is right



## 8 Matched motor

The following recommended motors are matched with BLDH-750. They have stable speed, large torque, low noise and low vibration.

### ■ 80mm\*80mm square BLDC motor

#### ◇ Electrical specification

Model	Output power (W)	Voltage (VDC)	Rated speed (RPM)	Rated torque (Nm)	Motor length (mm)
80BLF-5030HBB	500	310	3000	1.6	145
80BLF-7530HBB	750	310	3000	2.5	150

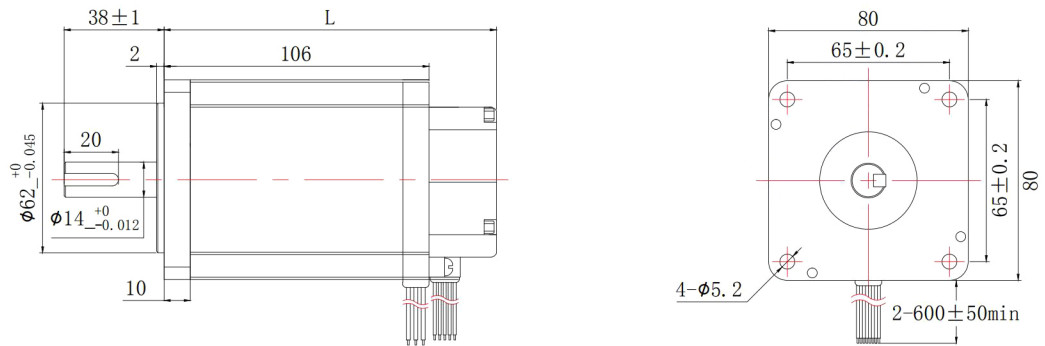

#### ◇ Electrical specification

80BLF-5030HBB

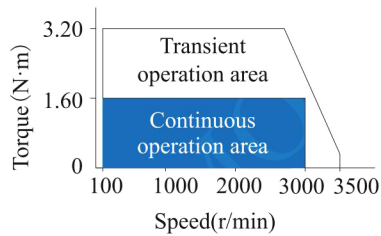

80BLF-7530HBB

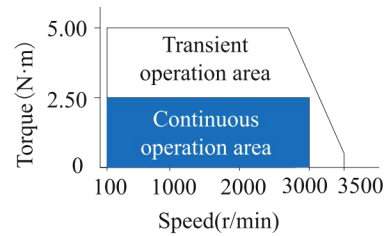

■ 86mm\*86mm square BLDC motor

◇ Electrical specification

Model	Output power (W)	Voltage (VDC)	Rated speed (RPM)	Rated torque (Nm)	Motor length (mm)
86BLF-4030HBB	400	310	3000	1.4	112
86BLF-5030HBB	500	310	3000	1.6	125

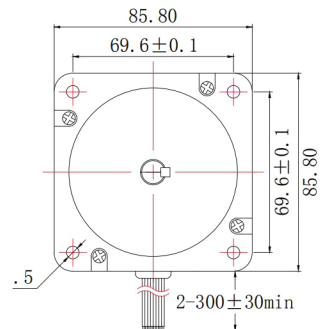
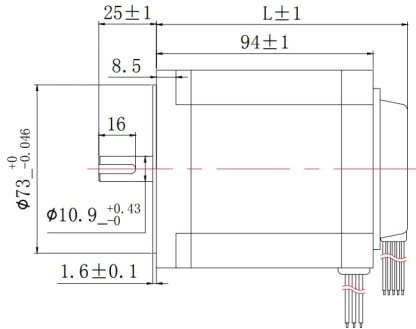

◇ Electrical specification

86BLF-4030HBB

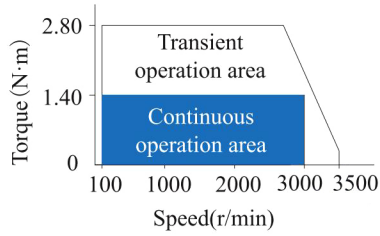

86BLF-5030HBB

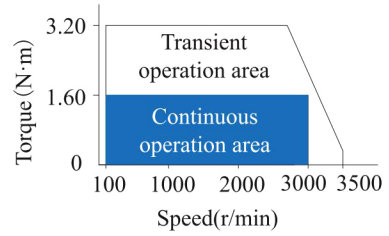

110mm\*110mm square BLDC motor

Electrical specification

Model	Output power (W)	Voltage (VDC)	Rated speed (RPM)	Rated torque (Nm)	Motor length (mm)
110BLF-6020HBB	630	310	3000	1.6	125

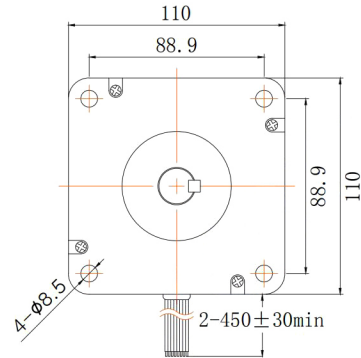
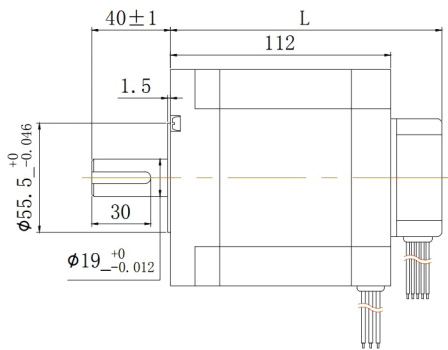

Electrical specification

110BLF-6020HBB

